

He is John Smith. His name is John Smith
Where is John Smith?
He is at the door of his house.

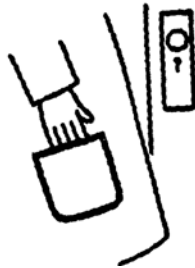

He has his hand in his pocket.



He is taking a key from his pocket.



This is a key.



These are other keys.

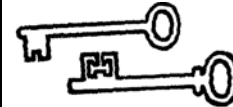

He will put the key in the lock of the door.

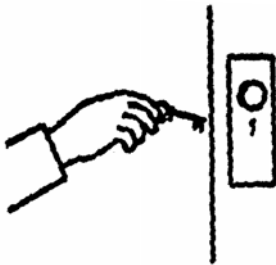

He is putting the key in the lock.

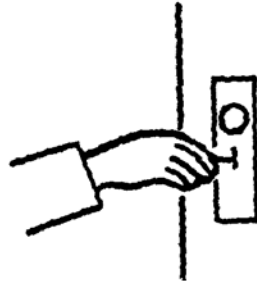

He is giving a turn to the key.



He is pushing the door.
The door is open now.



John took the key from the lock. He is putting it in his pocket. He will go into his house.

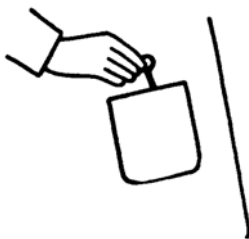

He is going into the house.



He went into the house.
He is in the house.
The door is closed.

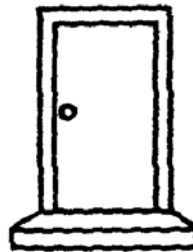

This is a room in the house. Is John in the room? No, he is not.

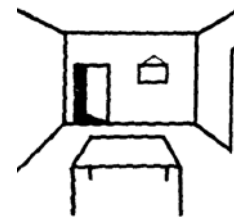

He will come into the room.

He is coming into the room. He will go to the table.

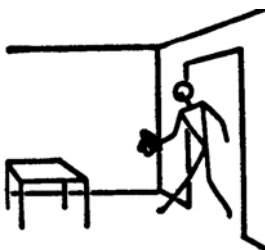

Mr. Smith came into the room. He went to the table.



Is Mrs. Smith in the room?



No, she is not.

She is in the house but she is not in the room. She is in another room in the house.

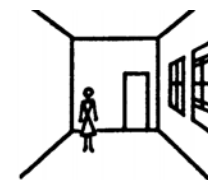

Who is this? This is Mary Smith. She is Mrs. Smith. Her name is Mary Smith.

This is one of the doors of the room.

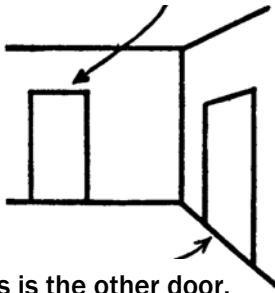

This is the other door.

This is one of the windows of the room.

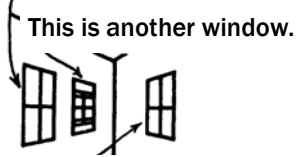

And this is another window. One window is open. The other windows are closed.

This is one of my hands. It is my left hand.



This is my other hand. It is my right hand.

This is one of my fingers.



This is my left thumb. These are the other fingers of my left hand.

Mrs. Smith is not in the room. She went out of the room.

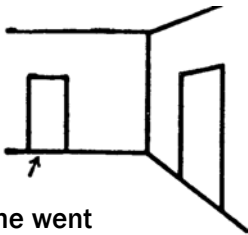

She went through this door.

Mr. Smith is in this room. He came into the room.

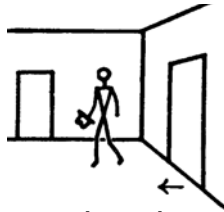

He came through this door.

Mr. Smith is putting his hat on the table.



He will go out of the room through this door.

He put his hat on the table. It is on the table now.

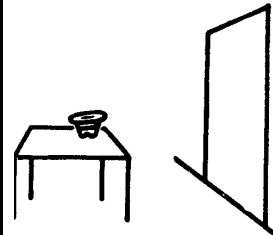

He went out of the room through this door.

Mary is coming into the room.

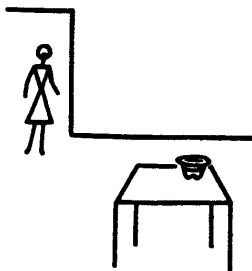

She is going to the table.

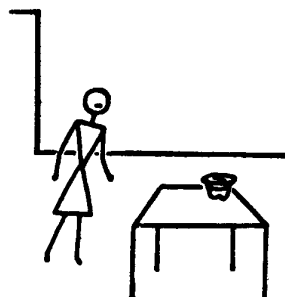

She will see the hat.

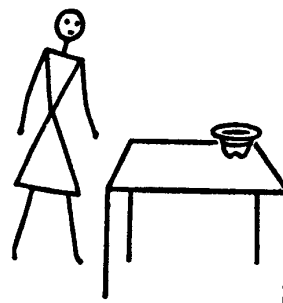

She sees it.

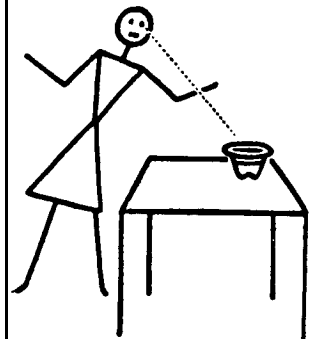

She saw it. When did she see it? She saw it after she went to the table.



What is that?

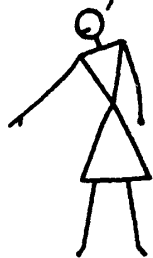

John's hat.



What is that? John's hat!



She will take the hat in her hand.



She is taking it.



She took it in her hand. She is going out of the room.

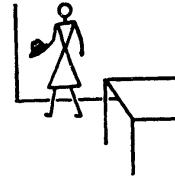

She has the hat in her hand.

She went out of the room with John's hat.

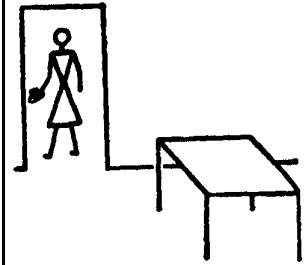

She is in another room now. She came into this room through this door.

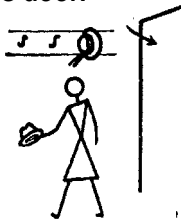

She has the hat with her.

What are these? They are hooks.

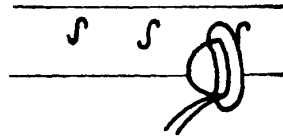

That is another hat. It is on a hook.

She will put John's hat on a hook.

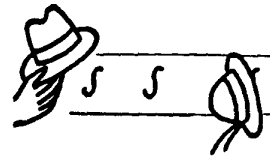

She will put it on a hook with the other hat.

She put it on the hook.

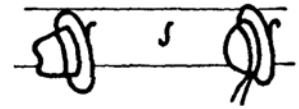

Now it is with the other hat. The other hat is one of Mary's hats.

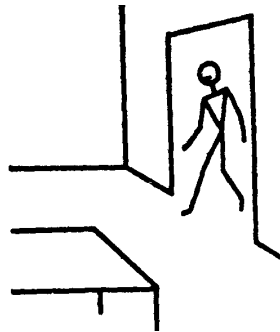

John is coming into the room again.

He came into the room. He went to the table.

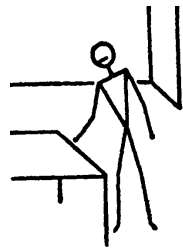

He is there now.

The hat is not on the table.

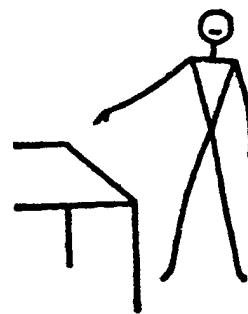

He is saying,

Where is my hat? I put it on the table.



"Where is my hat? It is not on my head. It isn't here."

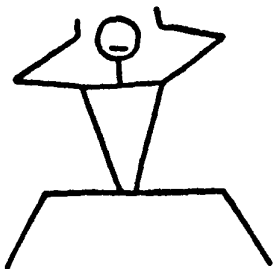

It isn't (is not) here."

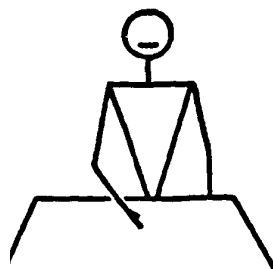

"Where is it? Mary, where is my hat? Where are you, Mary?"

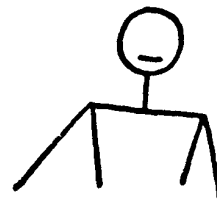

Here is Mary. She is coming into the room. She says, "Here I am."

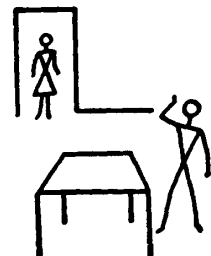

<p>"Where is your hat?"</p> 	<p>"You put it on the table. It was on the table."</p> 	<p>"I took it. I put it in the other room."</p> 	<p>"It is on a hook there. You will see it there."</p> 
<p>John says, "I will get my hat."</p> 	<p>He is getting it.</p> 	<p>Did he get it? Yes. He has it.</p> 	<p>He went out of the room.</p> 
<p>When he saw the hat he took it off the hook.</p> 	<p>He came into the room again with the hat in his hands. He got it.</p> 	<p>He is giving the hat to Mary.</p> 	<p>"See what is in the hat, Mary!"</p> 
<p>What is in the hat? Mary will see.</p> 	<p>What is she taking from the hat?</p> 	<p>What is that in her hand? It is money.</p> 	<p>Do you see? She sees.</p> 

What does she see?
One thousand dollars.

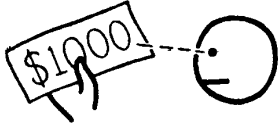

The money is in her hand. It was in the hat.

Where was the hat?
It was on the table.

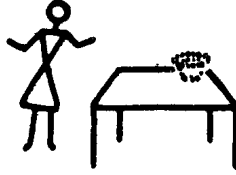

What did she see? She saw the hat. She did not see the money.

She put the hat in the other room. John went there and got it.

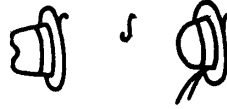

Who got it?
John got it.

Does she see the money? Yes, she sees it.

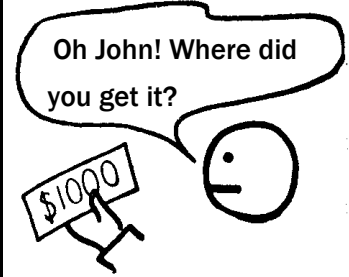

I was in the street.
I was coming here.

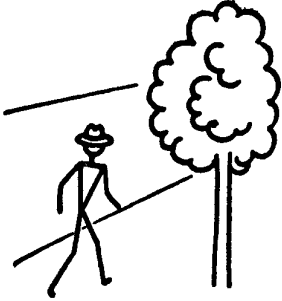

The wind came.
It took my hat off.

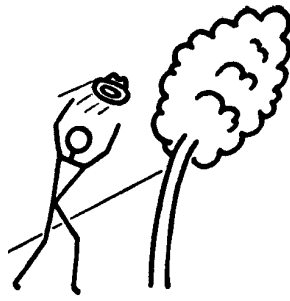

I went after my hat.

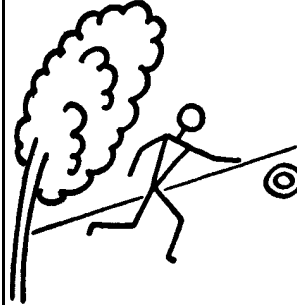

When I took it up, there was this money.

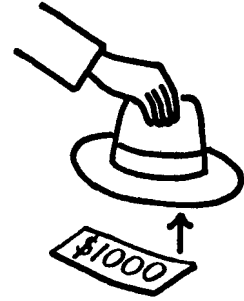

The money was under the hat.

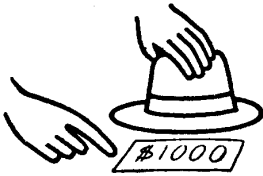

The hat was over the money.

The wind came.
My hat went up.
When the wind came,
my hat went up.

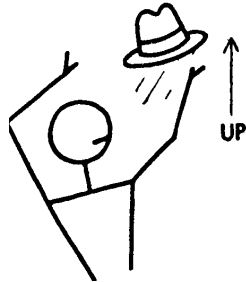

The hat came down again.

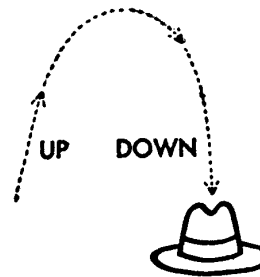

It was over the money.
The money was under the hat.

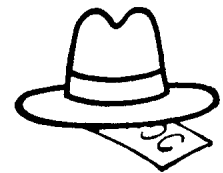



He is going into the house.

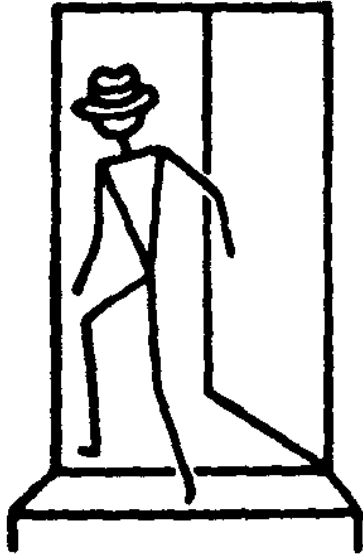

He is going into the room. He will go to the table.

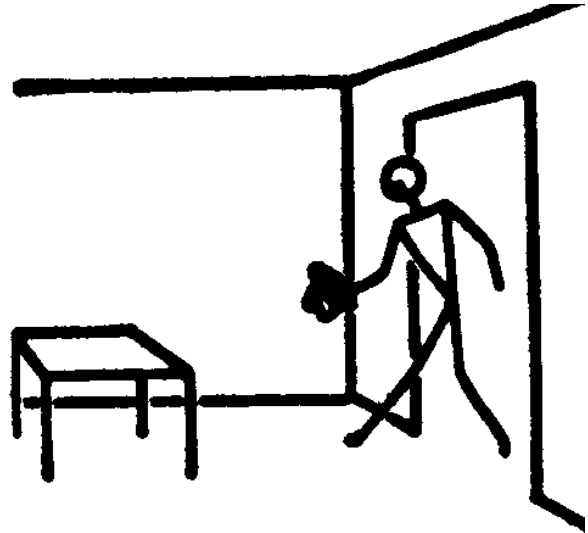

He is putting his hat on the table.

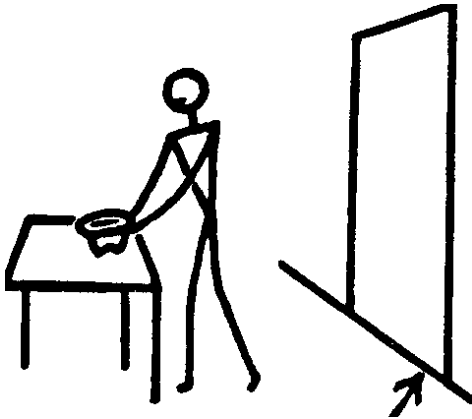

He will go out of the room through this door.

She went out of the room with John's hat.

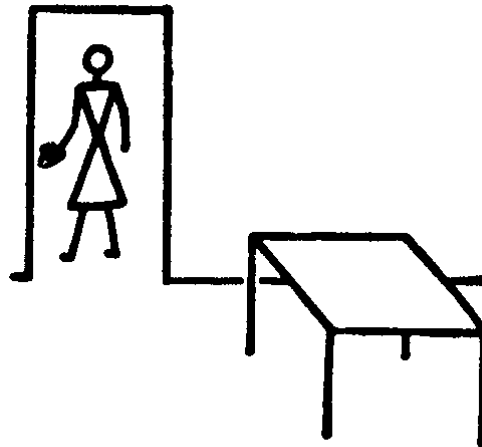

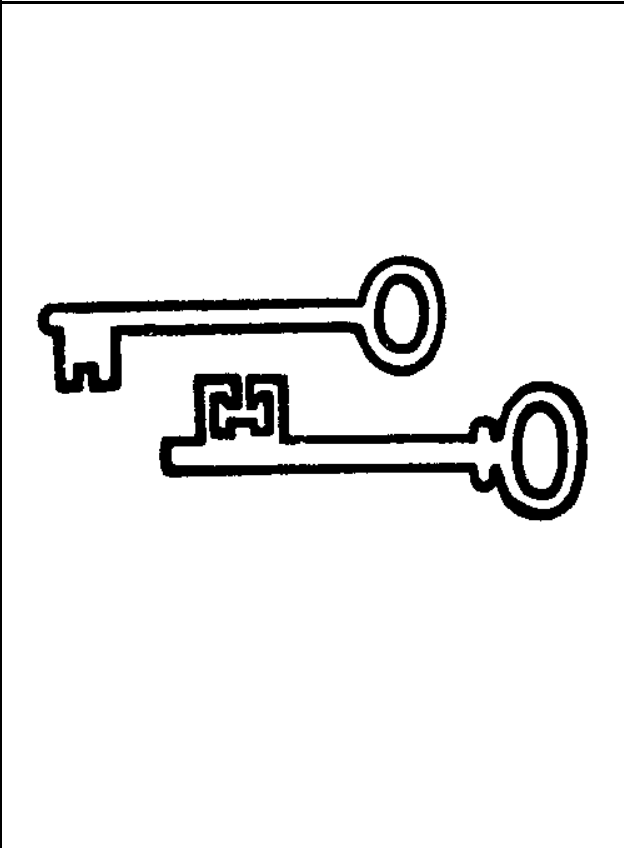
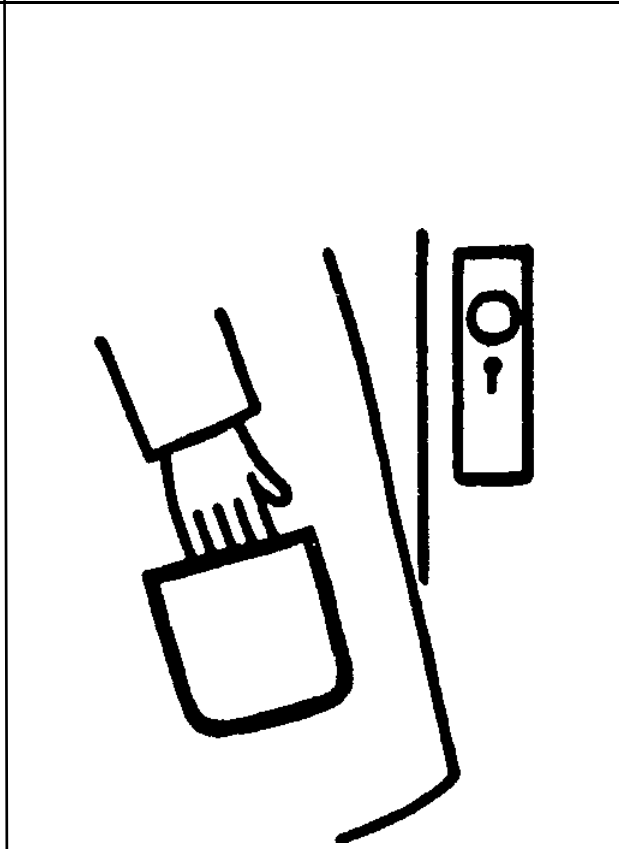
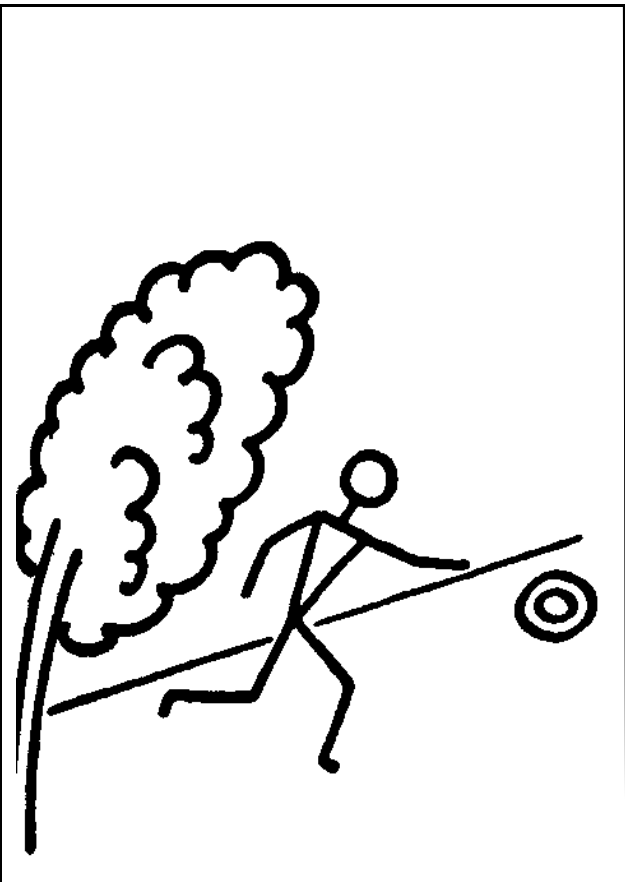
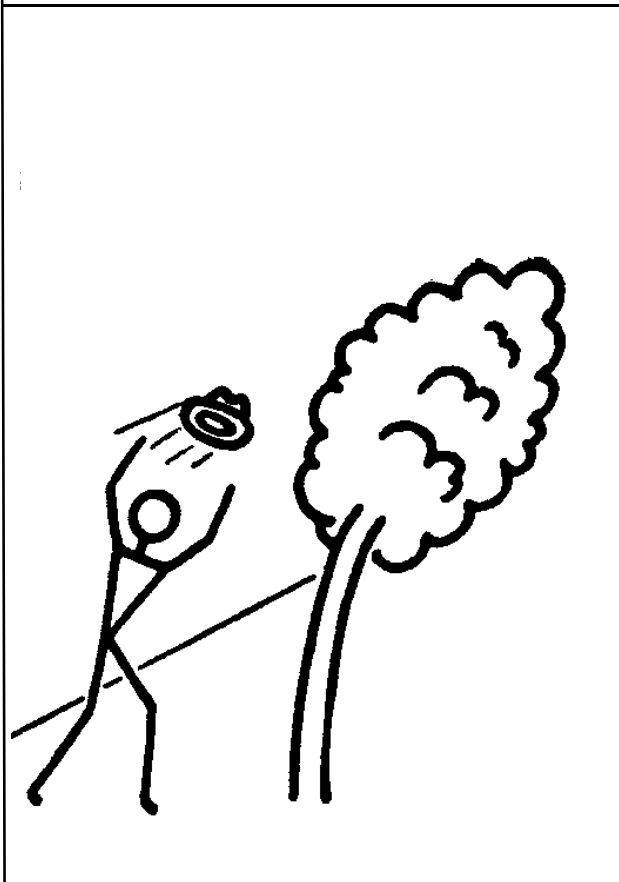

**The wind came.
It took my hat off.**

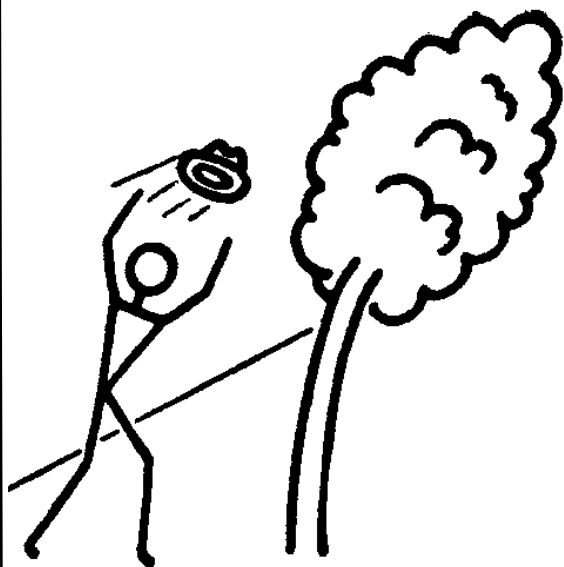

I went after my hat.

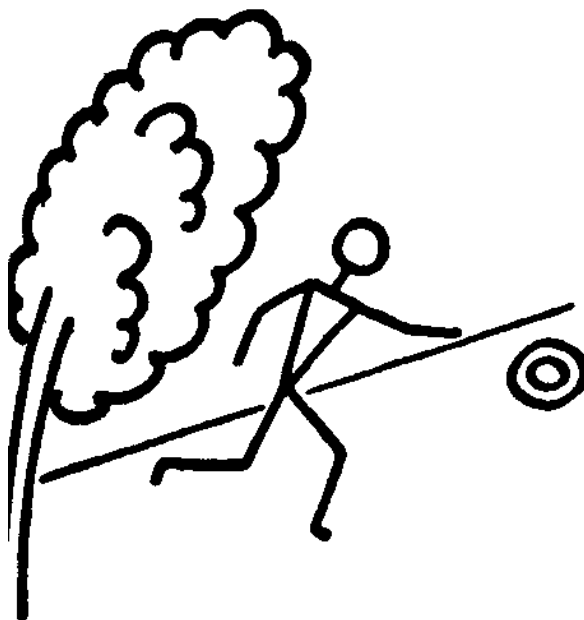

**He has his hand in his
pocket.**

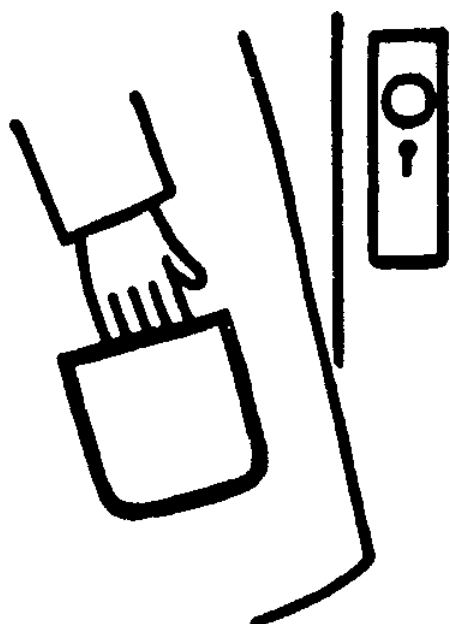

These are keys.

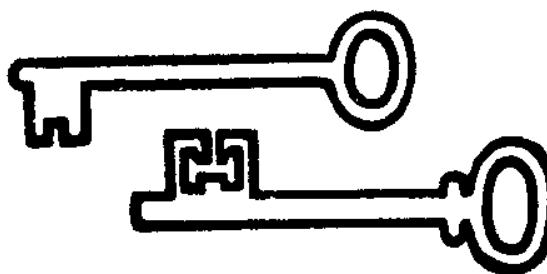

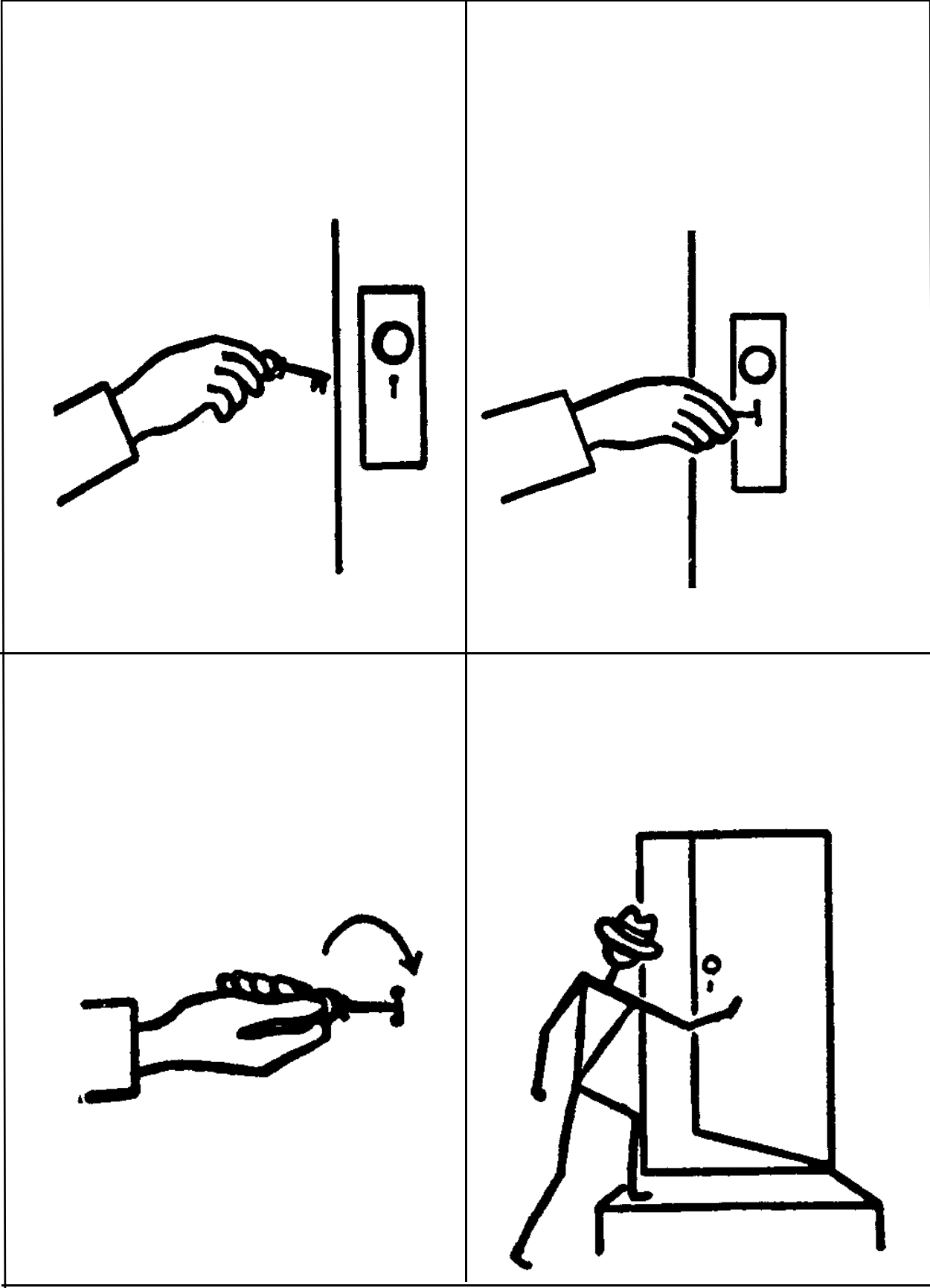

He will put the key in the lock of the door.

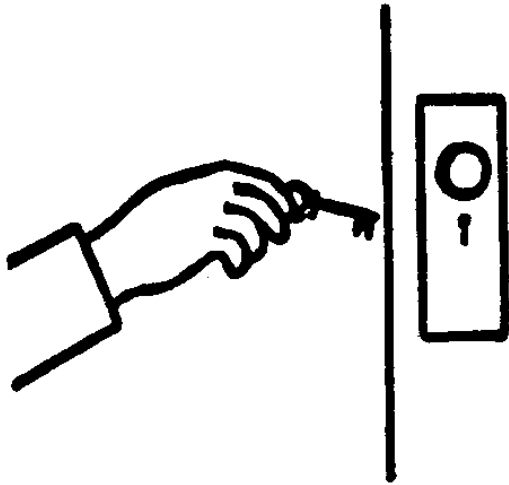

He is putting the key in the lock.

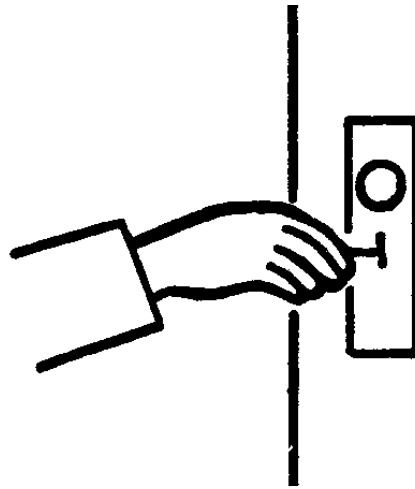

He is giving a turn to the key.



**He is pushing the door.
The door is open now.**

